



HBC84E653B HBC84E623B HBC84E663B HBC84E653B
Microwave



BOSCH

[en] Instruction manual

Important safety information	2	Changing the basic settings	11
Causes of damage	4	Basic settings	11
Your new appliance	5	Care and cleaning	11
Control panel	5	Cleaning agents	12
Buttons and display	5	Malfunction table	12
Function selector	5	Malfunction table	13
Temperature selector	6	Replacing the oven light bulb	13
Cooking compartment	6	After-sales service	14
Accessories	6	E number and FD number	14
Before using the appliance for the first time	7	Technical data	14
Setting the clock	7	Environmentally-friendly disposal	14
Heating up the oven	7	Automatic programmes	15
Cleaning the accessories	7	Setting a programme	15
Setting the oven	7	Defrosting and cooking with the automatic programmes	15
Setting the type of heating and temperature	7	Tested for you in our cooking studio	17
Rapid heating	7	Defrosting, heating up and cooking with the microwave	17
The microwave	8	Microwave tips	20
Notes regarding ovenware	8	Cakes and pastries	20
Microwave power settings	8	Baking tips	21
Setting the microwave	8	Roasting and grilling	21
MicroCombi operation	8	Tips for roasting and grilling	23
Setting MicroCombi	9	Bakes, gratins	23
1, 2, 3 series of operations	9	Frozen convenience products	23
Setting the Series of operations function	9	Test dishes	23
Setting the time-setting options	9	Baking	24
Timer	9	Grilling	24
Setting the cooking time	10	Acrylamide in foodstuffs	24
Setting the clock	10		
Childproof lock	11		
Switching on the childproof lock	11		
Switching off the childproof lock	11		
Childproof lock with automatic programmes	11		

Additional information on products, accessories, replacement parts and services can be found at www.bosch-home.com and in the online shop www.bosch-eshop.com

Important safety information

Read these instructions carefully. Only then will you be able to operate your appliance safely and correctly. Retain the instruction manual and installation instructions for future use or for subsequent owners.

This appliance is only intended to be fully fitted in a kitchen. Observe the special installation instructions.

Check the appliance for damage after unpacking it. Do not connect the appliance if it has been damaged in transport.

Only a licensed professional may connect appliances without plugs. Damage caused by incorrect connection is not covered under warranty.

This appliance is intended for domestic use only. The appliance must only be used for

the preparation of food and drink. The appliance must be supervised during operation. Only use this appliance indoors.

This appliance may be used by children over the age of 8 years old and by persons with reduced physical, sensory or mental capabilities or by persons with a lack of experience or knowledge if they are supervised or are instructed by a person responsible for their safety how to use the appliance safely and have understood the associated hazards.

Children must not play with, on, or around the appliance. Children must not clean the appliance or carry out general maintenance unless they are at least 8 years old and are being supervised.

Keep children below the age of 8 years old at a safe distance from the appliance and power cable.

Always slide accessories into the cooking compartment correctly. See "*Description of accessories*" in the instruction manual.

Risk of fire!

- Combustible items stored in the cooking compartment may catch fire. Never store combustible items in the cooking compartment. Never open the appliance door if there is smoke inside. Switch off the appliance and unplug it from the mains or switch off the circuit breaker in the fuse box.
- Using the appliance for anything other than its intended purpose is dangerous and may cause damage. The following is not permitted: drying out food or clothing, heating slippers, grain or cereal pillows, sponges, damp cleaning cloths or similar. For example, heated slippers and grain or cereal pillows may catch fire, even several hours after they have been heated. The appliance must only be used for the preparation of food and drinks.
- Food may catch fire. Never heat food in heat-retaining packages. Do not leave food heating unattended in containers made of plastic, paper or other combustible materials. Do not select a microwave power or time setting that is higher than necessary. Follow the information provided in this instruction manual. Never use the microwave to dry food. Never defrost or heat food with a low water content, e.g. bread, at too high a microwave power or for too long.
- Cooking oil may catch fire. Never use the microwave to heat cooking oil on its own.

Risk of explosion!

Liquids and other food may explode when in containers that have been tightly sealed. Never heat liquids or other food in containers that have been tightly sealed.

Risk of serious damage to health!

- The surface of the appliance may become damaged if it is not cleaned properly. Microwave energy may escape. Clean the appliance on a regular basis, and remove any food residue immediately. Always keep the cooking compartment, door seal,

door and door stop clean; see also section *Care and cleaning*.

- Microwave energy may escape if the cooking compartment door or the door seal is damaged. Never use the appliance if the cooking compartment door or the door seal is damaged. Contact the after-sales service.
- Microwave energy will escape from appliances that do not have any casing. Never remove the casing. For any maintenance or repair work, contact the after-sales service.

Risk of electric shock!

- Incorrect repairs are dangerous. Repairs may only be carried out and damaged power cables replaced by one of our trained after-sales technicians. If the appliance is defective, unplug the appliance from the mains or switch off the circuit breaker in the fuse box. Contact the after-sales service.
- The cable insulation on electrical appliances may melt when touching hot parts of the appliance. Never bring electrical appliance cables into contact with hot parts of the appliance.
- Do not use any high-pressure cleaners or steam cleaners, which can result in an electric shock.
- When replacing the cooking compartment bulb, the bulb socket contacts are live. Before replacing the bulb, unplug the appliance from the mains or switch off the circuit breaker in the fuse box.
- A defective appliance may cause electric shock. Never switch on a defective appliance. Unplug the appliance from the mains or switch off the circuit breaker in the fuse box. Contact the after-sales service.
- The appliance is a high-voltage appliance. Never remove the casing.

Risk of burns!

- The appliance becomes very hot. Never touch the interior surfaces of the cooking compartment or the heating elements. Always allow the appliance to cool down. Keep children at a safe distance.
- Accessories and ovenware become very hot. Always use oven gloves to remove

accessories or ovenware from the cooking compartment.

- Alcoholic vapours may catch fire in the hot cooking compartment. Never prepare food containing large quantities of drinks with a high alcohol content. Only use small quantities of drinks with a high alcohol content. Open the appliance door with care.
- Foods with peel or skin may burst or explode during, or even after, heating. Never cook eggs in their shells or reheat hard-boiled eggs. Never cook shellfish or crustaceans. Always prick the yolk when baking or poaching eggs. The skin of foods that have a peel or skin, such as apples, tomatoes, potatoes and sausages, may burst. Before heating, prick the peel or skin.
- Heat is not distributed evenly through baby food. Never heat baby food in closed containers. Always remove the lid or teat. Stir or shake well after the food has been heated. Check the temperature of the food before it is given to the child.
- Heated food gives off heat. The ovenware may become hot. Always use oven gloves to remove ovenware or accessories from the cooking compartment.
- Airtight packaging may burst when food is heated. Always observe the instructions on the packaging. Always use oven gloves to remove dishes from the cooking compartment.

Risk of scalding!

- When you open the appliance door, hot steam may escape. Open the appliance door with care. Keep children at a safe distance.
- Water in a hot cooking compartment may create hot steam. Never pour water into the hot cooking compartment.
- There is a possibility of delayed boiling when a liquid is heated. This means that the liquid reaches boiling temperature without the usual steam bubbles rising to the surface. Even if the container only vibrates a little, the hot liquid may suddenly boil over and spatter. When heating, always place a spoon in the container. This will prevent delayed boiling.

Risk of injury!

- Scratched glass in the appliance door may develop into a crack. Do not use a

glass scraper, sharp or abrasive cleaning aids or detergents.

- Unsuitable ovenware may crack. Porcelain or ceramic ovenware can have small perforations in the handles or lids. These perforations conceal a cavity below. Any moisture that penetrates this cavity could cause the ovenware to crack. Only use microwave-safe ovenware.

Causes of damage

Caution!

- Creation of sparks. Metal - e.g. a spoon in a glass - must be kept at least 2 cm from the oven walls and the inside of the door. Sparks could irreparably damage the glass on the inside of the door.
- Water in the cooking compartment when the cooking compartment is hot. Never pour water into the cooking compartment when the cooking compartment is hot. Steam will be created. The temperature change can cause damage to the ceramic floor panel.
- Foil containers. Do not use foil containers in the appliance. They damage the appliance by producing sparks.
- Moist food. Do not store moist food in the closed cooking compartment for long periods. This will damage the enamel. Do not use the appliance to store food. This can lead to corrosion.
- Cooling with the appliance door open. Only leave the cooking compartment to cool with the door closed. Do not trap anything in the appliance door. Even if the door is only slightly ajar, the fronts of adjacent units may be damaged over time.
- Heavily soiled seal. If the seal is very dirty, the appliance door will no longer close properly during operation. The fronts of adjacent units could be damaged. Always keep the seal clean.
- Using the appliance door for standing on or placing objects on. Do not stand or place anything on the open appliance door. Do not place ovenware or accessories on the appliance door.
- Transporting the appliance. Do not carry or hold the appliance by the door handle. The door handle cannot support the weight of the appliance and could break.
- Operating the microwave without food. Operating the appliance without food in the cooking compartment may lead to overloading. Never switch on the appliance unless there is food in the cooking compartment. An exception to this rule is a short crockery test (see the section "Microwave, suitable crockery").
- Never use the enamel baking tray when cooking with microwave operation. It will result in a technical fault.
- Microwave popcorn. Never set the microwave power too high. Use a power setting no higher than 600 watts. Always place the popcorn bag on a glass plate. The disc may jump if overloaded.

Your new appliance

Use this section to familiarise yourself with your new appliance. The control panel and the individual operating controls are

explained. You will find information on the cooking compartment and the accessories.

Control panel

You see here an overview of the control panel. Depending on the appliance model, there may be differences in the particular details.

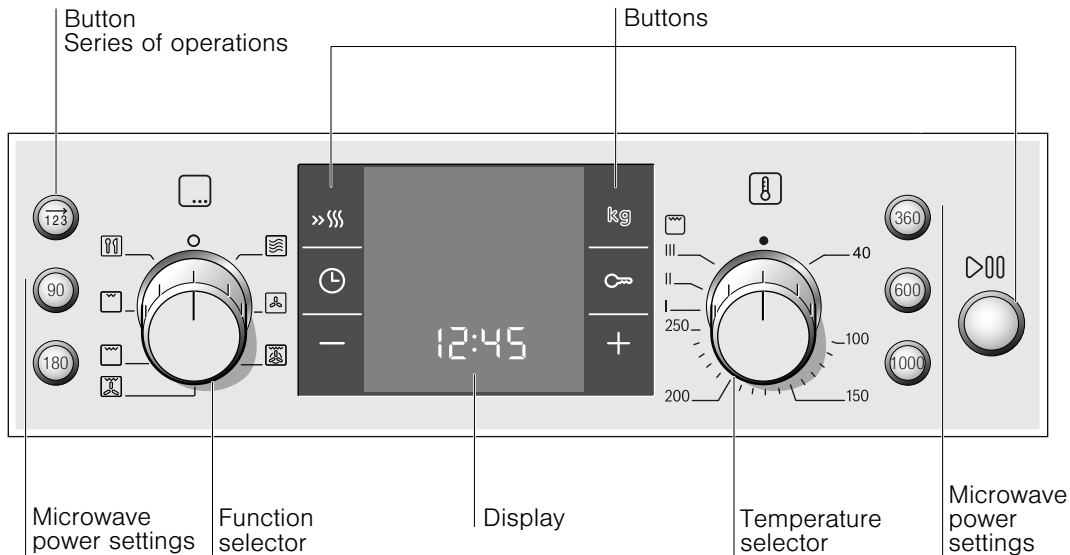

Control knobs

The control knobs are retractable. To lock it in or out, press the control knob in the off position.

Buttons

The sensors are located under the individual buttons. They must not be pressed too firmly. Only touch the corresponding symbol.

Exception: The button for the series of operations, the buttons for the microwave power settings and the Start/Pause button are normal push buttons.

Buttons and display

Using the buttons, you can set various functions. You can read the values that you have set on the display.

Button	Use
→ 123	Selects the Series of operations function
90	Selects 90 watt microwave power setting
180	Selects 180 watt microwave power setting
360	Selects 360 watt microwave power setting
600	Selects 600 watt microwave power setting
1000	Selects 1000 watt microwave power setting
>>>	Selects rapid heating
kg	Kilogrammes Selects the kilogrammes for the programmes.
⌚	Time-setting options Opens and closes the time-setting options menu.
🔒	Selects childproof lock

Button	Use
-	Minus Decreases the adjustment values.
+	Plus Increases the adjustment values.
▶	Start/Pause Press briefly = starts/stops operation Press and hold = cancels operation

Notes

- Which time-setting option is shown in the foreground on the display is indicated by the brackets [] around the corresponding symbol. Exception: for the clock, the ⌚ symbol only lights up when you are making changes.
- When you press the ▶||| button, the oven light switches on in the cooking compartment.

Function selector

Use the function selector to set the type of heating.

Setting	Use
○	Off position The oven is switched off.
🔥	Microwave Selects microwave operation.
🍞	Hot air For baking sponge cakes in baking tins, flans and cheesecakes as well as cakes, pizza and small baked items on the baking tray.
🔥	Heated air grilling Is particularly suitable for roasting pieces of meat.
🔥	Hot air grilling Poultry turns brown and crispy. Baked casseroles and grilled dishes come out best using this setting.

Setting	Use
Grill, large area	Select between the levels high, medium or low. This is ideal if you wish to grill several steaks, sausages, pieces of fish or slices of bread.
Grill, small area	This type of heating is ideal for cooking small quantities. Place the items to be grilled next to each other in the centre of the wire rack.
Programmes	4 defrosting programmes 11 cooking programmes The type of heating and cooking time are set according to weight.

Temperature selector

The temperature selector is used to set the temperature or grill setting.

Setting	Meaning
● Off position	The oven does not heat up.
40, 100-250	Temperature range The temperature in the oven in °C.
I, II, III	Grill settings The grill settings for "Grill, large area". I = setting 1, low II = setting 2, medium III = setting 3, high

The symbol remains lit on the display until the oven has reached the set temperature.

Cooking compartment

Your appliance has a cooling fan.

Cooling fan

The cooling fan switches on and off as required. The hot air escapes above the door.

Caution!

do not cover the ventilation slots. Otherwise the oven will overheat.

Notes

- The cooling fan continues to run for a certain time after operation.
- The appliance remains cool during microwave operation. The cooling fan will still switch on. The fan may run on even when microwave operation has ended.
- Condensation may appear on the door window, interior walls and floor. This is normal and does not adversely affect microwave operation. Wipe away the condensation after cooking.

Accessories

The accessories can be inserted into the appliance at four different heights.

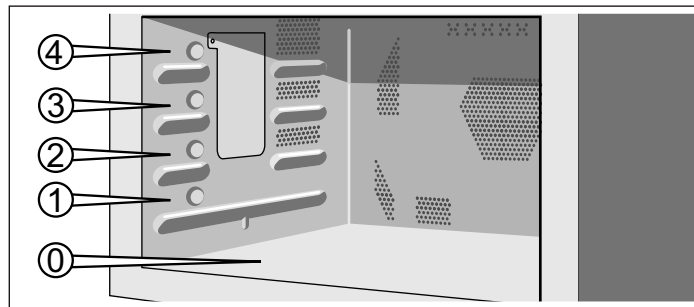

Note: Microwaveable ovenware can be placed on the oven floor (level 0).

Caution!

- Do not insert the enamel baking tray on the oven floor (level 0).
- Do not use any enamel baking trays or unsuitable microwave dishes while operating the microwave.

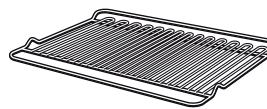

Wire rack

For ovenware, cake tins, grilled food and frozen meals.

Note: You can pull the wire rack two thirds of the way out without it tipping. This allows meals to be removed more easily.

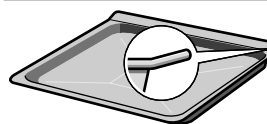

Enamel baking tray

For cakes and biscuits.

Note: Slide the baking tray with the tapered edge as far as possible into the oven.

Caution!

Do not use the enamel baking tray when operating the microwave and microwave combi.

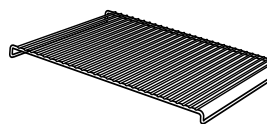

Wire rack

For grilled food. Always place the wire rack in the enamel baking tray. This ensures that dripping fat and meat juices are collected.

Caution!

The wire rack is not suitable for operation with the microwave.

Special accessories

You can obtain further accessories from the after-sales service or from specialist retailers.

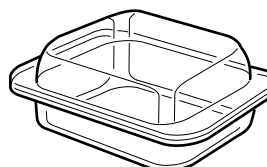

Glass roasting dish HEZ915001

For pot roasts and bakes that you prepare in the oven. It is particularly suitable for automatic programmes.

Before using the appliance for the first time

Here you will find everything you need to do before using your oven to prepare food for the first time. First read the section on *Safety information*.

Setting the clock

Once the appliance has been connected to the power supply, four zeros flash in the display.

Set the clock.

1. Press the **+** or **-** button.

Default value **+**: 12:00

Default value **-**: 23:59

2. Use the **+** or **-** button to set the clock.

3. Press the **⏸** button.

The time is set.

Note: In order to reduce the energy consumption of your appliance in standby, you can hide the clock. Read about this in the *Changing basic settings* section.

Heating up the oven

To remove the new cooker smell, heat up the oven when it is empty and closed. Make sure that the oven contains no leftover packaging, e.g. polystyrene pellets.

Heat the oven for 60 minutes with the  Hot air grill at 200 °C.

Note: Ventilate the kitchen while the oven is heating up.

1. Use the function selector to set the  Hot air grill.

2. Set the temperature to 200 °C using the temperature selector.

3. Press the **▷|||** button.

The oven begins to heat up.

4. After 60 minutes, switch off the oven. To do so, turn the function selector to the zero position.

Once the oven has cooled, clean it with hot, soapy water.

Cleaning the accessories

Before you use the accessories for the first time, clean them thoroughly with hot soapy water and a soft dish cloth.

Setting the oven

There are various ways in which you can set your oven. Here we will explain how you can select the desired type of heating and temperature or grill setting. You can also select the oven cooking time for your dish. Please refer to the section on *Setting the time-setting options*.

Setting the type of heating and temperature

Example in the picture: Heated air grilling  at 200 °C.

1. The function selector is used to set the type of heating.

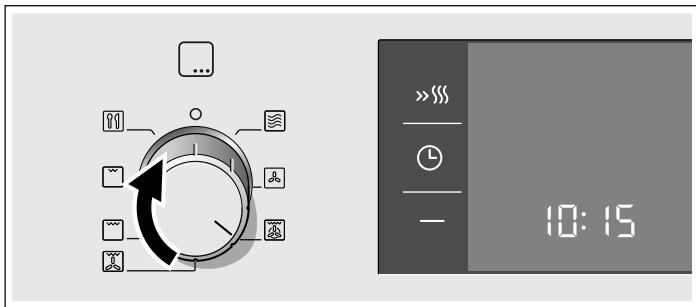

2. The temperature selector is used to set the temperature or grill setting.

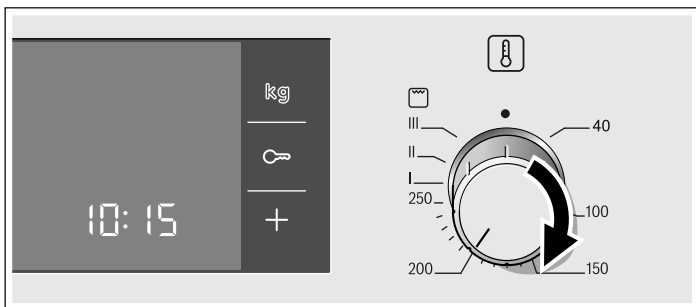

3. Press the **▷|||** button.

The oven begins to heat up.

Opening the oven door during operation

Operation is suspended. After closing the door, press the **▷|||** button. Operation will then continue.

Pausing operation

Press the **▷|||** button to pause operation. Press the **▷|||** button to continue operation.

Changing the settings

The type of heating and temperature or grill setting can be changed at any time using their respective selectors.

Switching off the oven



Turn the function selector to the off position.

Rapid heating

With rapid heating, your oven reaches the temperature set particularly quickly.

Use the rapid heating function when temperatures above 100 °C are set.

The best type of heating for this is

-  Hot air
-  Heated air grilling
-  Hot air grilling

To ensure an even cooking result, do not place your food in the cooking compartment until rapid heating is complete.

Setting rapid heating

1. Set the type of heating and temperature.

2. Press the **»|||** button.

The **»|||** symbol lights up on the display.

3. Press the **▷|||** button.

The oven begins to heat up.

The rapid heating process is complete

A signal sounds. The **»|||** symbol in the display goes out. Put your dish in the oven.

Cancelling rapid heating

Press the »||| button. The »||| symbol in the display goes out.

The microwave

Microwaves are converted to heat in foodstuffs. The microwave can be used solo, i.e. on its own, or in combination with a different type of heating. You will find information about ovenware and how to set the microwave.

Note:

In the *Tested for you in our cooking studio* section, you will find examples for defrosting, heating and cooking with the microwave oven.

Notes regarding ovenware

Suitable ovenware

Suitable dishes are heat-resistant ovenware made of glass, glass ceramic, porcelain, ceramic or heat-resistant plastic. These materials allow microwaves to pass through.

You can also use serving dishes. This saves you having to transfer food from one dish to another. You should only use ovenware with decorative gold or silver trim if the manufacturer guarantees that they are suitable for use in microwaves.

Unsuitable ovenware

Metal ovenware is unsuitable. Metal does not allow microwaves to pass through. Food in covered metal containers will remain cold.

Caution!

Creation of sparks: metal – e.g. a spoon in a glass – must be kept at least 2 cm from the oven walls and the inside of the door. Sparks could destroy the glass on the inside of the door.

Ovenware test

Do not switch on the microwave unless there is food inside. The following ovenware test is the only exception to this rule.

Perform the following test if you are unsure whether your ovenware is suitable for use in the microwave:

1. Heat the empty ovenware at maximum power for ½ to 1 minute.

2. Check the temperature occasionally during that time.

The ovenware should still be cold or warm to the touch.

The ovenware is unsuitable if it becomes hot or sparks are generated.

Microwave power settings

Use the button to set the desired microwave power.

90 W	for defrosting delicate foods
180 W	for defrosting and continued cooking
360 W	for cooking meat and heating delicate foods
600 W	for heating and cooking food
1000 W	for heating liquids

Notes

- When you press a button, the selected power lights up.
- The microwave power can be set to 1000 watts for a maximum of 30 minutes. With all other power settings a maximum cooking time of 1 hour 30 minutes is possible.

Setting the microwave

Example: Microwave power 600W, cooking time 17 minutes.

1. Set the function selector to .
2. Press the button for the microwave power setting you require. The 600 W power level lights up and a suggested cooking time is displayed.
3. Use the + or – button to set the cooking time.
4. Press the ▷||| button.

Operation begins. The cooking time starts counting down.

The cooking time has elapsed

A signal sounds. Microwave operation has finished. Turn the function selector to the zero position. You can stop the audible signal by pressing the ⊕ button.

Opening the oven door during cooking

Operation is suspended. After closing the door, press the ▷||| button briefly. The programme will then continue.

Changing the cooking time

This can be done at any time. Use the + or – button to change the cooking time.

Changing the microwave power setting

Press the button for the new microwave power setting. Use the + or – button to set the cooking time and restart the microwave.

Pausing operation

Press the ▷||| button briefly. The oven is paused. Press the ▷||| button again to continue operation.

Cancelling operation

Press and hold the ▷||| button for approximately 4 seconds and turn the function selector to the off position.

Notes





- When you set the function selector to , the highest microwave power setting always lights up as the suggested setting.
- If you open the appliance door during cooking, the fan may continue to run.

MicroCombi operation

This involves the simultaneous operation of one of the types of heating together with the microwave. Using the microwave makes your dishes ready more quickly, but they are still nicely browned.

You can switch on all microwave power settings. Exception: 1000 watts

Suitable types of heating

-  Hot air
-  Heated air grilling
-  Hot air grilling
-  Grill, large area
-  Grill, small area

Setting MicroCombi

Example: Microwave 360 W, 17 minutes and Hot air  190 °C.

1. Set the type of heating using the function selector, and the temperature using the temperature selector.
2. Press the button for the microwave power setting you require. A suggested cooking time appears.
3. Use the **+** or **-** button to set the cooking time.
4. Press the  button.

Operation starts. The cooking time starts counting down.

The cooking time has elapsed

A signal sounds. Combination mode has finished. You can stop the audible signal by pressing the  button.

1, 2, 3 series of operations









You can use the SeriesOperations function to set up to three different microwave power settings and times and then start.

Ovenware

Always use microwave-safe, heat-resistant ovenware.

Setting the Series of operations function

Set a cooking time for each operation in the series.



1. Set the function selector to .
2. Press the  button.
The  for the first operation in the series appears on the display.
3. Set the first microwave power setting and cooking time.
4. Press the  button.
The  for the second operation in the series appears.
5. Set the second microwave power setting and cooking time.
6. Press the  button.
The  for the third operation in the series appears.
7. Set the third microwave power setting and cooking time.
8. Press the  button.

Operation starts. The total cooking time appears.

Opening the oven door during cooking

Operation is suspended. After closing the door, press the  button briefly. The programme will then continue.

Pausing operation

Press the  button briefly. The oven is paused. Press the  button again to continue operation.

Changing the cooking time

This can be done at any time. Use the **+** or **-** button to change the cooking time.

Changing the microwave power setting

Press the button for the new microwave power setting. Use the **+** or **-** button to set the cooking time and restart the microwave.

Cancelling operation

Press and hold the  button for approximately 4 seconds or turn the function selector and temperature selector back to the off position.

The cooking time has elapsed

A signal sounds. The series of operations is finished. You can stop the audible signal by pressing the  button.



Changing the setting

Changes can only be made before operation begins. Press the  button repeatedly until the number for the series of operations appears. Change the setting.

Opening the oven door during cooking

Operation is suspended. After closing the door, press the  button briefly. The programme will then continue.

Pausing operation

Press the  button briefly. The oven is paused. Press the  button again to continue operation.

Cancelling operation

Press and hold the  button for approximately 4 seconds or turn the function selector to the off position.

Checking the cooking time

Press the  button twice.

Note: You can also combine a type of heating with the Series of operations function. Set the type of heating first.

Setting the time-setting options

Your oven has various time-setting options. You can use the  button to call up the menu and switch between the individual functions. All the time symbols are lit when you can make settings. The brackets [] show you which time-setting option you have currently selected. A time-setting option which has already been set can be changed directly with the **+** or **-** button when the relevant time symbol is in brackets.

Timer

You can use the timer as a kitchen timer. It runs independently of the oven. The timer has its own signal. In this way, you can tell whether it is the timer or a cooking time which has elapsed.

1. Press the  button once.

The time symbols light up in the display and the brackets are around .

2. Use the **+** or **-** button to set the timer duration.

Default value for **+** button = 10 minutes

Default value for **-** button = 5 minutes

After a few seconds, the time setting is adopted. The timer starts. The [🔔] symbol lights up in the display and the timer duration counts down. The other time symbols go out.

The timer duration has elapsed

A signal sounds. 00:00 is shown in the display. Use the ⏸ button to switch off the timer.

Changing the timer duration

Use the **+** or **-** button to change the timer duration. After a few seconds, the change is adopted.

Clearing the timer period

Use the **-** button to reset the Timer duration to as far as 0:00. The change will be adopted after a few seconds. The Timer is switched off.

Checking time settings

If several time-setting options have been set, the corresponding symbols appear on the display. The timer counts down in the foreground. The [🔔] symbol is in brackets and the timer can be seen counting down.

To check the Timer 🔔, Cooking time 🕒 or Clock ⌚, press the ⏸ button repeatedly until the brackets are around the relevant symbol. The value is shown for a few seconds on the display.

Setting the cooking time

The cooking time for your meal can be set on the oven. When the cooking time has elapsed, the oven switches off automatically. This means that you do not have to interrupt other work to switch off the oven. The cooking time cannot be accidentally exceeded.

Example in the picture: Cooking time 45 minutes.

1. The function selector is used to set the type of heating.

2. The temperature selector is used to set the temperature or grill setting.

3. Press the ⏸ button twice.

20:00 appears in the display. The time symbol lights up, and the brackets are around 🕒.

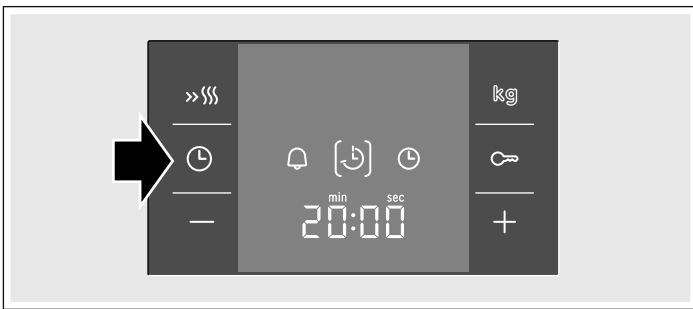

4. Use the **+** or **-** button to set the cooking time.



5. Press the ▶🔔 button.

The oven starts. The cooking time counts down in the display and the [🕒] symbol lights up. The other time symbols go out.

The cooking time has elapsed

An audible signal sounds. The oven stops heating. The status bar shows 0:00. You can cancel the signal before it has finished by pressing the ⏸ button. Turn the function selector to the zero position. The oven is switched off.

Changing the cooking time

Use the **+** or **-** button to change the cooking time. The change is applied after a few seconds.

When the Timer is counting down: Press the ⏸ button and change the Cooking time with the **+** or **-** button.

Cancelling the cooking time

Use the **-** button to reset the cooking time to 0:00. The change is applied after a few seconds. The cooking time has been cancelled.

When the Timer is counting down: Press the ⏸ button beforehand.

Checking time settings

If several time-setting options have been set, the corresponding symbols light up on the display.

To check the Timer 🔔, Cooking time 🕒 or Clock ⌚, press the ⏸ button repeatedly until the brackets are around the relevant symbol. The value is shown for a few seconds on the display.

Setting the clock

When the appliance has been connected to the power supply, or after a power cut, the [⌚] symbols and four zeros light up on the display.

Set the clock.

1. Press the **+** or **-** button.

Default value **+**: 12:00

Default value **-**: 23:59

2. Use the **+** or **-** button to set the clock.

3. Press the ⏸ button.

The time is set.

Changing the time

No other time-setting option should be set.

1. Press the ⏸ button twice.

The time symbols light up on the display and the brackets are around [⌚].

2. Use the **+** or **-** button to change the time.

The time which has been set is applied after a few seconds.

Hiding the clock

You can hide the clock. For more information, please refer to the section *Changing the basic settings*.

Childproof lock

The oven has a childproof lock to prevent children switching it on accidentally.

The oven will not react to any settings. The timer and clock can also be set when the childproof lock has been switched on.

Switching on the childproof lock

Requirement: No cooking time should be set and the function selector is in the zero position.

Press and hold the  button for approx. four seconds.

The  symbol appears in the display. The childproof lock is switched on.

Switching off the childproof lock

Press and hold the  button for approx. four seconds.

The  symbol on the display goes out. The childproof lock is switched off.

Childproof lock with automatic programmes





When automatic programmes have been set, the childproof lock is not operational.

Changing the basic settings



Your appliance has various basic settings which you can change at any time.

Basic settings



In the table, you will find all the basic settings and options for changing them.

Basic setting	Options	Explanation
 1 Clock display 1 = on	Clock display 2 = off	Displays the clock
 2 Signal duration: 2 = medium = 2 minutes	Signal duration: 1 = short = 10 seconds 3 = long = 5 minutes	Signal after the cooking time has elapsed
 3 Button tone: 1 = on	Button tone: 2 = off	Confirmation tone when a button is pressed
 4 Waiting time: 2 = medium = 5 seconds	Waiting time: 1 = short = 2 seconds 3 = long = 10 seconds	Waiting time between two separate steps, after setting
 5 Signal volume: 2 = medium	Signal volume: 1 = low 3 = high	Volume of the signal

Requirement: Your appliance is switched off.

1. Press and hold the  button for several seconds.
The first basic setting appears in the display.
2. Use the  or  button to change the basic setting.

3. Confirm by pressing the  button.

The next basic setting appears in the display. You can go through all of the basic settings using the  button and make changes using the  or  button.

4. When finished, press and hold the  button for several seconds.

All settings are applied.

You can change the settings at any time.

Care and cleaning

With careful care and cleaning your microwave oven will retain its looks and remain good order. We will explain here how you should care for and clean your appliance correctly.

Risk of short circuit!

Never use high-pressure cleaners or steam cleaners to clean the oven.

Risk of burns!

Never clean the appliance immediately after switching off. Let the appliance cool down.

Notes

- Slight differences in colour on the front of the appliance are caused by the use of different materials, such as glass, plastic and metal.
- Shadows on the door panel which look like streaks, are caused by reflections made by the oven light.

- Enamel is baked on at very high temperatures. This can cause some slight colour variations. This is normal and does not affect their function. The edges of thin trays cannot be completely enamelled. As a result, these edges can be rough. This will not impair the anti-corrosion protection.
- Unpleasant odours, e.g. after fish has been prepared, can be removed very easily. Add a few drops of lemon juice to a cup of water. Place a spoon into the container as well, to prevent delayed boiling. Heat the water for 1 to 2 minutes at maximum microwave power.

Cleaning agents

To ensure that the different surfaces are not damaged by using the wrong cleaning agent, observe the information in the table. Do not use:

- any caustic or abrasive cleaning agents,
- metal or glass scrapers to clean the glass in the appliance door,
- metal or glass scrapers to clean the door seal,
- hard scouring pads and sponges,
- cleaning agents with high concentrations of alcohol.

Rinse out new sponge cloths thoroughly before use.

For easier cleaning, you can switch on the oven light. Open the appliance door to do so.

Area	Cleaning agents
Appliance front	Hot soapy water: Clean using a dish cloth and then dry with a soft cloth. Do not use glass cleaners or metal or glass scrapers for cleaning.
Stainless steel	Hot soapy water: Clean using a dish cloth and then dry with a soft cloth. Remove traces of limescale, grease, starch and albumin (e.g. egg white) immediately. Corrosion can form under such residues. Special stainless steel cleaning agents can be obtained from the after-sales service or from specialist retailers.
Cooking compartment made of stainless steel	Hot soapy water or a vinegar solution: Clean using a dish cloth and then dry with a soft cloth. If the oven is very dirty: use oven cleaner, but only when cooking compartment is cold. It is best to use a stainless-steel sponge. Do not use oven spray or other aggressive oven cleaners or abrasive materials. Scouring pads, rough sponges and pan cleaners are also unsuitable. These agents scratch the surface. Allow the interior surfaces to dry thoroughly.

Area	Cleaning agents
Door panels	Glass cleaner: Clean with a dish cloth. Do not use a glass scraper.
Glass cover for the cooking compartment light	Hot soapy water: Clean with a dish cloth.
Door seal Do not remove.	Hot soapy water: Clean with a dish cloth; do not scrub. Do not use a metal or glass scraper for cleaning.
Accessories	Hot soapy water: Soak and clean with a dish cloth or a brush.

Cleaning the glass cover

The glass oven-light cover is located on the left side wall inside the oven. Undo the screw from the cover. Then you can clean the glass with soapy water.

Self-cleaning surface in the cooking compartment

The back panel of the oven is coated with self-cleaning enamel. It cleans itself while the oven is in operation. Sometimes, larger splashes of food may not disappear until the oven has been operated several times.

Notes

- Never treat the self-cleaning surface with oven cleaner. If oven cleaner accidentally gets onto the rear wall, remove it immediately with a sponge and plenty of water.
- Never use abrasive cleaning agents. You will scratch or destroy the highly porous coating.
- Never clean the self-cleaning surface with a scouring pad.
- Light discolouration of the enamel does not affect self-cleaning.

Cleaning the cooking compartment floor, ceiling and side walls

Use a dish cloth and hot soapy water or a vinegar solution.

It is best to use oven cleaner if there are very heavy deposits of dirt. Only use oven cleaner in a cold oven.

Malfunction table

Malfunctions often have simple explanations. Please refer to the malfunction table before calling the after-sales service.

If a meal does not turn out exactly as you wanted, refer to the *Tested for you in our cooking studio* section, where you will find plenty of cooking tips and tricks.

Risk of electric shock!

Incorrect repairs are dangerous. Repairs may only be carried out by one of our trained after-sales engineers.

Malfunction table

Problem	Possible cause	Remedy/information
The appliance does not work	Faulty circuit breaker	Look in the fuse box to make sure that the fuse for the appliance is OK.
	Plug not plugged in	Plug the plug in
	Power cut	Check whether the kitchen light is working.
	Incorrect operation	Switch off the circuit breaker in the fuse box. Switch it back on after approx. 10 seconds.
Three zeros are flashing in the display.	Power cut	Reset the clock.
The appliance is not in operation. A cooking time appears on the display.	The ▷ button was not pressed after the setting had been made.	Press the ▷ button or switch the appliance off.
The microwave does not switch on.	The door was not fully closed.	Check whether food remains or foreign material is trapped in the door. Make sure that the seal surfaces are clean. Check whether the door seal is twisted.
	The ▷ button has not been pressed.	Press the ▷ button.
It takes longer than before for the food to heat up.	The microwave power setting is too low.	Select a higher power setting.
	A larger amount than usual has been placed in the appliance.	Double the amount = almost double the time
	The food was colder than usual.	Stir or turn the food during cooking
An audible signal sounds. The two dots in the display are flashing.	The appliance is in demonstration mode.	1. Press the $\vec{123}$ button.
		2. Press and hold the kg button for three seconds.
		Demo mode is deactivated.

Error messages

You can take remedial action yourself for some error messages.

Error message	Possible cause	Remedy/Note
Error message "Er1" or "Er4" appears in the display.	The temperature sensor has failed.	Call the after-sales service.
Error message "Er11" appears in the display. "Button jammed"	The buttons are dirty or the mechanics have jammed.	Press all buttons several times and, if this does not help, contact the after-sales service.
Error message "Er19" appears in the display.	There is extreme overheating (possibly a fire inside). Microwave power setting too high.	Do not open the door. Disconnect from the mains or switch off the fuse in the fuse box and allow to cool down.
Error message "Er17", "Er18" or "E305" appears in the text display.	Technical malfunction.	Call the after-sales service.

Replacing the oven light bulb

It is possible to replace the oven light. Heat-resistant 240 V, 25 W halogen bulbs can be obtained from after-sales service or a specialist retailer.

Risk of electric shock!

Never replace the oven light when the appliance is switched on. Pull out the mains plug or switch off the appliance at the circuit breaker in the fuse box.

Note: Always remove the new halogen bulb from the packaging using a dry cloth. This increases the service life of the bulb.

Method

Note: You must remove the whole appliance in order to replace the cooking compartment light. Follow the installation instructions.

1. Unplug the appliance from the mains or switch off the circuit breaker in the fuse box.
2. Open the appliance door.
Undo the securing screws on the right and left-hand side of the oven. Follow the installation instructions.

3. Carefully lift out the appliance.
4. Undo the screw from the light cover on the outer left-hand side wall and remove the cover. (Fig. A) Pull out the halogen light. (Fig. B).

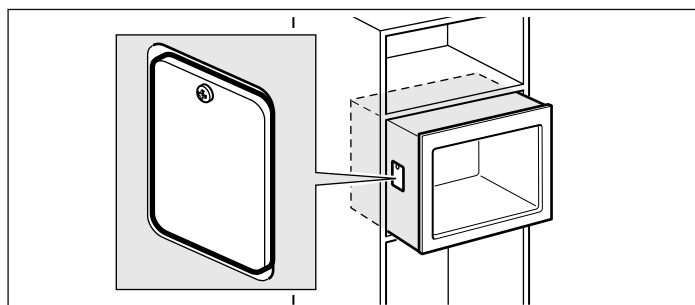

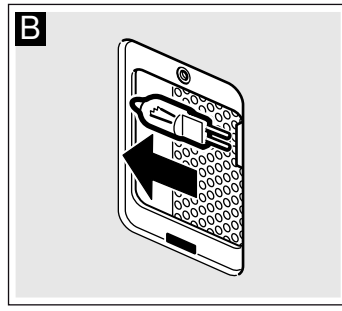
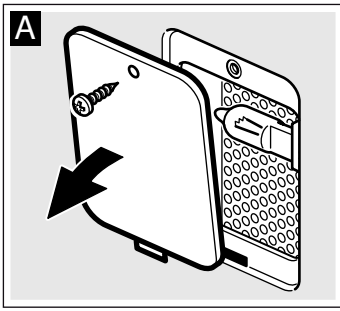

5. Insert the new halogen bulb (Fig. C)

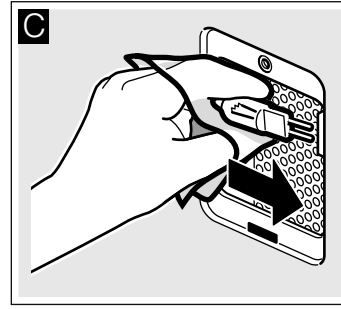

6. Screw the lamp cover in place.

Reassemble the appliance in the reverse order.

7. Switch the circuit breaker in the fuse box back on or plug in the mains plug.

Replacing the glass cover

If the glass cover in the oven is damaged, it must be replaced. You can obtain covers from the after-sales service. Please supply your appliance's E number and FD number.

After-sales service

Our after-sales service is there for you if your appliance needs to be repaired. We will always find the right solution in order to avoid unnecessary visits from a service technician.

E number and FD number

When calling us, please give the product number (E no.) and the production number (FD no.) so that we can provide you with the correct advice. The rating plate bearing these numbers can be found in the oven. You can make a note of the number of your appliance and the telephone number of the after-sales service in the space below to save time should it be required.

E no. _____ **FD no.** _____

After-sales service ☎

Please note that there will be a fee for a visit by a service technician in the event of a malfunction, even during the warranty period.

Please find the contact data of all countries in the enclosed customer service list.

To book an engineer visit and product advice

GB 0844 8928979
Calls from a BT landline will be charged at up to 3 pence per minute. A call set-up fee of up to 6 pence may apply.

IE 01450 2655
0.03 € per minute at peak. Off peak 0.0088 € per minute.

Trust the expertise of the manufacturer, and rest assured that the repair will be carried out by trained service technicians using original spare parts for your domestic appliance.

This appliance corresponds to the standards EN 55011 and CISPR 11. It is a Group 2, Class B product.

Group 2 means that microwaves are produced for the purpose of heating food. Class B states that the appliance is suitable for private households.

Technical data

Power supply	220 - 240 V, 50 Hz
Maximum total connected load	3100 W
Microwave power setting	1000 W (IEC 60705)
Grill output power	2000 W
Hot air output power	1950 W
Microwave frequency	2450 MHz
Fuse	15 A

Dimensions (HxWxD)

- appliance	454 x 595 x 563 mm
- cooking compartment	236 x 445 x 348 mm

VDE approved	yes
CE mark	yes

Environmentally-friendly disposal

Dispose of packaging in an environmentally-friendly manner.



This appliance is labelled in accordance with European Directive 2012/19/EU concerning used electrical and electronic appliances (waste electrical and electronic equipment - WEEE). The guideline determines the framework for the return and recycling of used appliances as applicable throughout the EU.

Automatic programmes

The automatic programmes enable you to prepare food very easily. You select the programme and enter the weight of your food. The automatic programme makes the optimum setting. You can choose from 15 programmes.

Setting a programme

When you have selected a programme, set the oven. The temperature selector must be in the zero position.

Example in diagram: Minced meat (programme 2) with a weight of 1 kilogramme.

1. Set the function selector to automatic programmes . The first programme number appears on the display.

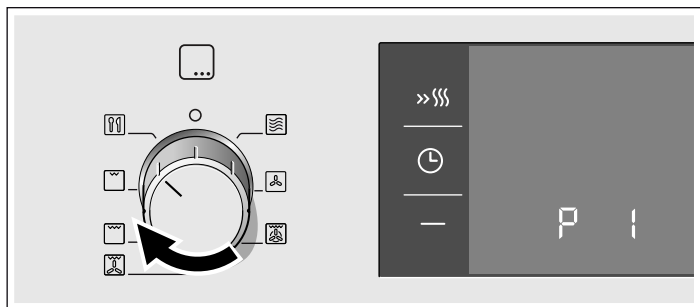

2. Use the + or - button to select the programme number.



3. Press the  button. The display shows 0.50 kilogrammes as the suggested weight.



4. Use the + or - button to set the weight.



5. Press the  button.

The programme starts. The cooking time starts counting down and the  symbol is in brackets.

The programme has finished

An audible signal sounds. The programme has finished and the oven stops heating. Press the  button and turn the function selector to the off position.

Changing the programme

Once you have started the programme, the programme number and weight cannot be changed.

Cancelling the programme

Turn the function selector to the zero position. The oven switches off.



Switching off the signal early

Press the  button.

Opening the appliance door during operation

Operation is suspended. After closing the door, press the  button briefly. Operation will then continue.

Pausing operation

Press the  button briefly. The oven is paused. Press the  button again to continue operation.

Cancelling the programme

Press and hold the  button for approximately 4 seconds and turn the function selector to the zero position. The oven switches off.

Changing the cooking time and end time

If using automatic programmes, you cannot change the cooking time or end time.

Defrosting and cooking with the automatic programmes

Notes

- Take the food out of its packaging and weigh it. If it is not possible to enter the exact weight, you should round it up or down.
- Always use microwaveable ovenware, e.g. made of glass, ceramic or the universal pan. Observe the accessories tips in the programme table.
- Place the food in the cold cooking compartment.
- A table of suitable types of food with appropriate weight ranges and the accessories required can be found in the section after the tips.
- It is not possible to set a weight outside the weight range.
- With many dishes, a signal sounds after a certain time. Turn or stir the food.

Defrosting

Notes

- As far as possible, freeze and store food flat and in portion-sized quantities at -18 °C.
- Place the frozen food on a flat ovenproof dish, e.g. a glass or porcelain plate.
- After defrosting, allow the food to defrost for a further 15 to 90 minutes until it reaches an even temperature.
- Liquid will be produced when defrosting meat, poultry or fish. Drain off this liquid when turning meat and poultry and under

no circumstances use it for other purposes or allow it to come into contact with other foods.

- Bread should only be defrosted in the required amounts, as it quickly becomes stale.
- After turning, remove any minced meat that has already defrosted.
- Whole poultry should be placed in the dish breast-side down and poultry portions skin-side down.

Vegetables

Notes

- Fresh vegetables: Cut into pieces of equal size. Add one tablespoon of water for every 100 g vegetables.
- Frozen vegetables: This programme is only suitable for blanched, not pre-cooked vegetables. It is not suitable for frozen vegetables in cream sauce. Add 1 to 3 tablespoons of water. Do not add water to spinach or red cabbage.

Boiled potatoes

Note: Cut into equal sized pieces. Add a little salt and a tablespoon of water for every 100 g of potatoes.

Rice

Notes

- Do not use boil-in-the-bag rice.
- Add two to two and a half times the amount of water to the rice.

Programme table

Progr. no.	Suitable food	Weight range in kg	Ovenware/accessories, shelf height	
Defrost				
1	Loaf of bread*	Wheat bread, mixed wheat bread, wholemeal bread	0.20 - 1.50	Flat ovenware without a lid Cooking compartment floor
2	Minced meat*	Minced beef, lamb, or pork	0.20 - 1.00	Flat ovenware without a lid Cooking compartment floor
3	Whole poultry*	Chicken, duck	0.60 - 2.00	Flat ovenware without a lid Cooking compartment floor
4	Fish fillet*	Fillet of pike, cod, rosefish, pollock, pike-perch	0.20 - 1.00	Flat ovenware without a lid Cooking compartment floor
* Observe the turning signals.				
Cooking				
5	Fresh vegetables*	Cauliflower, broccoli, carrots, kohlrabi, leeks, peppers, courgettes	0.20 - 1.00	Ovenware with lid Cooking compartment floor
6	Vegetables, frozen*	Cauliflower, broccoli, carrots, kohlrabi, red cabbage, spinach	0.20 - 1.00	Ovenware with lid Cooking compartment floor
7	Boiled potatoes*	Waxy potatoes, mainly waxy potatoes or floury potatoes	0.20 - 1.00	Ovenware with lid Cooking compartment floor
8	Rice, long grain rice		0.10 - 0.50	Deep ovenware with lid Cooking compartment floor
9	Steam fresh fish fillet	Fillet of pike, cod, rosefish, pollock, pike-perch	0.20 - 1.00	Ovenware with lid Cooking compartment floor
* Observe the stirring signals				
Combi-cooking				
10	Pizza, frozen	Pizza with thin base, prebaked	0.15 - 0.55	Wire rack Level 3
11	Lasagne bolognese, frozen		0.40 - 1.00	Ovenware without lid Cooking compartment floor
12	Chicken, fresh*	Whole chicken	0.80 - 1.80	Ovenware with lid Cooking compartment floor
13	Chicken portions, fresh	Chicken thigh, half chicken	0.40 - 1.60	Ovenware with lid Cooking compartment floor
14	Meat loaf	Approx. 8 cm deep	0.80 - 1.50	Ovenware without lid Cooking compartment floor

Fish

Note: Fish fillet, fresh: Add 1 to 3 tablespoons of water or lemon juice.

Meat

Note: The joint should cover two thirds of the dish base. Add 50 to 100 ml of liquid.

Poultry

Notes

- Place the chicken in the dish breast-side down.
- Place chicken portions in the dish flesh-side down.

Pizza, frozen

Note: Use prebaked, frozen pizza and pizza baguettes.

Resting times

Some dishes need to rest in the oven after the programme has ended.

Dish	Resting time
Vegetables	approx. 5 minutes
Boiled potatoes	approx. 5 minutes. First pour off the remaining water.
Rice	5 to 10 minutes
Joint of pork, meat loaf	10 minutes

Progr. no.	Suitable food	Weight range in kg	Ovenware/accessories, shelf height
15	Roast pork joint*	Boned neck joint, rolled roasting joint	0.80 - 2.00 Ovenware with lid Cooking compartment floor

* Observe the turning signals.

Tested for you in our cooking studio.

Here you will find a selection of recipes and the ideal settings for them. We will show you which type of heating and which temperature or microwave power setting is best for your meal. You can find information about suitable accessories and the height at which they should be inserted. There are also tips about ovenware and preparation methods.

Notes

- The values in the table always apply to food placed into the cooking compartment when it is cold and empty. Only preheat the appliance if the table specifies that you should do so. Before using the appliance, remove all accessories from the cooking compartment that you will not be using.
- Do not line the accessories with greaseproof paper until after they have been preheated.
- The times specified in the tables are only guidelines. They will depend on the quality and composition of the food.
- Use the accessories supplied. Additional accessories may be obtained from specialist retailers or from the after-sales service.
- Always use an oven cloth or oven gloves when taking accessories or ovenware out of the cooking compartment.

Risk of scalding!

When pulling out the enamel baking tray, hot liquid may overflow. Pull out the enamel baking tray carefully from the cooking compartment.

Defrosting, heating up and cooking with the microwave

The following tables provide you with numerous options and settings for the microwave.

Defrosting	Weight	Microwave power setting in watts, cooking time in minutes	Notes
Whole pieces of beef, veal or pork (on the bone or boned)	800 g	180 W, 15 mins + 90 W, 15-25 mins	Turn several times
	1 kg	180 W, 15 mins + 90 W, 25-35 mins	
	1.5 kg	180 W, 20 mins + 90 W, 25-35 mins	
Meat in pieces or slices of beef, veal or pork	200 g	180 W, 5 mins + 90 W, 4-6 mins	Separate any defrosted parts when turning
	500 g	180 W, 10 mins + 90 W, 5-10 mins	
	800 g	180 W, 10 mins + 90 W, 10-15 mins	
Minced meat, mixed	200 g	90 W, 15 mins	Freeze food flat if possible. Turn several times during defrosting and remove any minced meat that has already defrosted.
	500 g	180 W, 5 mins + 90 W, 10-15 mins	
	800 g	180 W, 10 mins + 90 W, 15-20 mins	
Poultry or poultry portions	600 g	180 W, 5 mins + 90 W, 10-15 mins	Turn during cooking.
	1.2 kg	180 W, 10 mins + 90 W, 20-25 mins	
Duck	2 kg	180 W, 20 mins + 90 W, 30-40 mins	Turn several times.
Goose	4.5 kg	180 W, 30 mins + 90 W, 60-80 mins	Turn every 20 minutes. Remove any liquid that results from defrosting.
Fish fillet, fish steak or slices	400 g	180 W, 5 mins + 90 W, 10-15 mins	Separate any defrosted parts.
Whole fish	300 g	180 W, 3 mins + 90 W, 10-15 mins	Turn during cooking.
	600 g	180 W, 8 mins + 90 W, 15-25 mins	

The times specified in the tables are only guidelines. They may vary according to the ovenware used, the quality, temperature and consistency of the food.

Time ranges are often specified in the tables. Set the shortest time first and then extend the time if necessary.

It may be that you have different quantities from those specified in the tables. A rule of thumb can be applied:

Double the amount - almost twice the cooking time,
Half the amount - half the cooking time.

Stir or turn the food several times during the heating time. Check the temperature.

Defrosting

Notes

- Place the frozen food in an open container on the oven floor.
- Delicate parts such as the legs and wings of chicken or fatty outer layers of roasts can be covered with small pieces of aluminium foil. The foil must not touch the cooking compartment walls. You can remove the foil half way through the defrosting time.
- Turn or stir the food once or twice during the defrosting time. Large pieces of food should be turned several times. Turn to remove any liquid that results from defrosting.
- Leave defrosted items to stand at room temperature for a further 10 to 60 minutes so that the temperature can stabilise. The giblets can be removed from poultry at this point.

Defrosting	Weight	Microwave power setting in watts, cooking time in minutes	Notes
Vegetables, e.g. peas	300 g	180 W, 10-15 mins	Stir carefully during defrosting.
	600 g	180 W, 10 mins + 90 W, 8-13 mins	
Fruit, e.g. raspberries	300 g	180 W, 7-10 mins	Stir carefully during defrosting and separate any defrosted parts.
	500 g	180 W, 8 mins + 90 W, 5-10 mins	
Butter, defrosting	125 g	90 W, 6-8 mins	Remove all packaging.
	250 g	180 W, 2 mins + 90 W, 3-5 mins	
Loaf of bread	500 g	180 W, 3 mins + 90 W, 10-15 mins	Turn during cooking.
	1 kg	180 W, 5 mins + 90 W, 15-25 mins	
Cakes, dry, e.g. sponge cake	500 g	90 W, 10-15 mins	Only for cakes without icing, cream or crème pâtissière, separate the pieces of cake.
	750 g	180 W, 3 mins + 90 W, 10-15 mins	
Cakes, moist, e.g. fruit flan, cheese-cake	500 g	180 W, 5 mins + 90 W, 15-20 mins	Only for cakes without icing, cream or gelatine
	750 g	180 W, 7 mins + 90 W, 15-20 mins	

Defrosting, heating up or cooking frozen food

Notes

- Take ready meals out of the packaging. They will heat up more quickly and evenly in microwaveable ovenware. The different components of the meal may not require the same amount of time to heat up .
- Food which lies flat will cook more quickly than food which is piled high. You should therefore distribute the food so that it is as flat as possible in the ovenware. Different foodstuffs should not be placed in layers on top of one another.

- Always cover the food. If you do not have a suitable cover for your ovenware, use a plate or special microwave foil.
- Stir or turn the food 2 or 3 times during cooking.
- After heating, allow the food to stand for a further 2 to 5 minutes so that it can achieve an even temperature.
- Always use an oven cloth or oven gloves when removing plates from the oven.
- This will help the food retain its own distinct taste, so it will require less seasoning.

Defrosting, heating up or cooking frozen food	Weight	Microwave power setting in watts, cooking time in minutes	Notes
Menu, plated meal, ready meal (2-3 components)	300-400 g	600 W, 11-15 mins	Covered
Soup	400-500 g	600 W, 8-13 mins	Ovenware with lid
Stews	500 g	600 W, 10-15 mins	Ovenware with lid
	1 kg	600 W, 20-25 mins	
Slices or pieces of meat in sauce, e.g. goulash	500 g	600 W, 12-17 mins	Ovenware with lid
	1 kg	600 W, 25-30 mins	
Fish, e.g. fillets	400 g	600 W, 10-15 mins	Covered
	800 g	600 W, 20-25 mins	
Side dishes, e.g. rice, pasta	250 g	600 W, 2-5 mins	Ovenware with lid; add liquid
	500 g	600 W, 8-10 mins	
Vegetables, e.g. peas, broccoli, carrots	300 g	600 W, 8-10 mins	Ovenware with lid, add 1 tbsp of water
	600 g	600 W, 14-17 mins	
Creamed spinach	450 g	600 W, 11-16 mins	Cook without additional water

Heating food

Risk of scalding!

There is a possibility of delayed boiling when a liquid is heated. This means that the liquid reaches boiling temperature without the usual steam bubbles rising to the surface. Even if the container only moves a little, the hot liquid can suddenly boil over and spatter. When heating liquids, always place a spoon in the container. This will prevent delayed boiling.

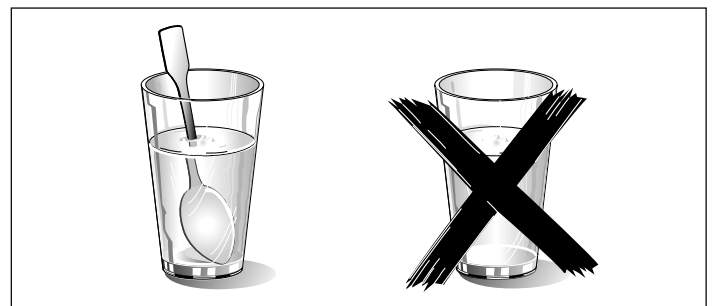

Caution!

Metal - e.g. a spoon in a glass - must be kept at least 2 cm from the oven walls and the inside of the door. Sparks could irreparably damage the glass on the inside of the door.

Notes

- Take ready meals out of the packaging. They will heat up more quickly and evenly in microwavable ovenware. The different components of the meal may not require the same amount of time to heat up.
- Always cover the food. If you do not have a suitable cover for your container, use a plate or special microwave foil.

- Stir or turn the food several times during the heating time. Check the temperature.
- After heating, allow the food to stand for a further 2 to 5 minutes so that it can achieve an even temperature.
- Always use an oven cloth or oven gloves when removing plates from the oven.

Heating food	Weight	Microwave power setting in watts, cooking time in minutes	Notes
Menu, plated meal, ready meal (2-3 components)	350-500 g	600 W, 4-8 mins	Covered
Drinks	150 ml	1000 W, 1-2 mins	Place a spoon in the glass; do not overheat alcoholic drinks; check occasionally while heating
	300 ml	1000 W, 2-3 mins	
	500 ml	1000 W, 4-5 mins	
Baby food, e.g. baby bottle	50 ml	360 W, ½-1 mins	No teats or lids. Always shake well after heating. You must check the temperature
	100 ml	360 W, ½-1½ mins	
	200 ml	360 W, 1-2 mins	
Soup 1 cup	175 g each	600 W, 2-3 mins	-
Soup, 2 cups	175 g each	600 W, 3-4 mins	-
Soup, 4 cups	175 g each	600 W, 6-8 mins	-
Meat or pieces of meat in sauce	500 g	600 W, 8-11 mins	Covered
Stew	400 g	600 W, 6-8 mins	Ovenware with lid
	800 g	600 W, 8-11 mins	
Vegetables, 1 portion	150 g	600 W, 2-3 mins	Add a little liquid
Vegetables, 2 portions	300 g	600 W, 3-5 mins	

Cooking food

Notes

- Food which lies flat will cook more quickly than food which is piled high. You should therefore distribute the food so that it is as flat as possible in the ovenware. Different foodstuffs should not be placed in layers on top of one another.
- Cook the food in ovenware with a lid. If you do not have a suitable lid for your ovenware, use a plate or special microwave foil.

- This will help the food retain its own distinct taste, so it will require less seasoning.
- After cooking, allow the food to stand for a further 2 to 5 minutes so that it can achieve an even temperature.
- Always use an oven cloth or oven gloves when removing plates from the oven.

Cooking food	Weight	Microwave power setting in watts, cooking time in minutes	Notes
Whole chicken, fresh, no giblets	1.2 kg	600 W, 25-30 mins	Turn halfway through the cooking time
Fish fillet, fresh	400 g	600 W, 7-12 mins	-
Vegetables, fresh	250 g	600 W, 6-10 mins	Cut vegetables into pieces of equal size. Add 1 to 2 tbsp water per 100 g of vegetables. Stir during cooking
	500 g	600 W, 10-15 mins	
Sweet foods, e.g. blancmange (instant)	500 ml	600 W, 6-8 mins	Stir the custard pudding thoroughly 2 to 3 times during cooking using an egg whisk.
Fruit, compote	500 g	600 W, 9-12 mins	-
Side dishes			
e. g. potatoes	250 g	600 W, 8-10 mins	Cut the potatoes into pieces of equal size; Add 1 to 2 tbsp water for every 100 g. Stir during cooking
	500 g	600 W, 12-15 mins	
	750 g	600 W, 15-22 mins	
e.g. rice	125 g	600 W, 4-6 mins + 180 W, 12-15 mins	Add double the amount of liquid.
	250 g	600 W, 6-8 mins + 180 W, 15-18 mins	

Microwave tips

You cannot find any information about the settings for the quantity of food you have prepared.	Increase or reduce the cooking times using the following rule of thumb: Double the amount = almost double the cooking time Half the amount = half the cooking time
The food has become too dry.	Next time, set a shorter cooking time or select a lower microwave power setting. Cover the food and add more liquid.
When the time has elapsed, the food is not defrosted, hot or cooked.	Set a longer time. Large quantities and food which is piled high require longer times.
When the time has elapsed, the food is overheated at the edge but not done in the middle.	Stir it during the cooking time and next time, select a lower microwave power setting and a longer cooking time.
After defrosting, the poultry or meat is defrosted on the outside but not defrosted in the middle.	Next time, select a lower microwave power setting. If you are defrosting a large quantity, turn it several times.

Cakes and pastries

About the tables

Notes

- The times given apply to food placed in a cold oven.
- The temperature and baking time depend on the consistency and amount of the mixture. This is why temperature ranges are given in the tables. Begin with the lower temperature and,

if necessary, use a higher setting the next time, since a lower temperature results in more even browning.

- Additional information can be found in the *Baking tips* section following the tables.
- Always place the cake tin in the centre of the wire rack.

Baking tins

Note: It is best to use dark-coloured metal baking tins.

Cakes in tins	Accessories	Level	Type of heating	Temperature °C	Cooking time in minutes
Sponge cake, simple or sponge cake, delicate (e.g. sand cake)*	Ring-shaped cake tin/Vienna ring tin/	1		160-170	60-80
	cake tin	1		150-160	60-70
Sponge flan base with edge made from shortcrust pastry	Springform cake tin	1		160-170	35-45
Sponge flan base	Flan base cake tin	1		160-170	35-45
Sponge flan (hot water sponge cake)	Springform cake tin	1		170-180	45-50
Cake with dry topping (sponge)	Baking tray	2		160-170	30-40
Cake with moist topping e.g. yeast dough with apple crumble	Baking tray	2		150-160	50-60
Plaited loaf with 500 g flour	Baking tray	2		160-170	30-40
Stollen with 500 g flour	Baking tray	2		170-180	60-70
Pizza	Baking tray	2		200-210	25-35
Yeast bread 1 kg**	Baking tray	2		180-190	50-60



* Allow cake to cool in the oven for approx. 20 minutes.

** Never pour water directly into a hot oven.

Cake	Ovenware	Level	Microwave power in watts	Cooking time in minutes	Type of heating	Temperature in °C
Nut cake	Springform cake tin	1	90 W	30-35		170-180
Fruit tart or cheesecake with shortcrust pastry*	Springform cake tin	2	360 W	40-50		150-160
Fruit pie, delicate with sponge	Ring cake tin or springform cake tin	1	90 W	30-45		170-190
Savoury cakes (e.g. quiche/ onion tart)	Springform cake tin or quiche tin	2	90 W	50-70		160-180

* Allow cake to cool in the oven for approx. 20 minutes.

Small baked items	Level	Type of heating	Temperature in °C	Cooking time in minutes
Biscuits	2		150-170	20-35
Meringue	2		100	90-120
Macaroons	2		110	35-45

Small baked items		Level	Type of heating	Temperature in °C	Cooking time in minutes
Puff pastry	Baking tray	2		170-180	35-45
Bread rolls (e.g. rye bread rolls)	Baking tray	2		180-190	35-45

Baking tips

You want to bake according to your own recipe.	Use similar items in the baking tables as a guide.
Use baking tins made of silicone, glass, plastic or ceramic materials.	The baking tin must be heat-resistant up to 250 °C. Cakes in these baking tins will be less brown. When using the microwave, the cooking time will be shorter than the time shown in the table.
How to establish whether sponge cake is baked through.	Approximately 10 minutes before the end of the baking time specified in the recipe, poke the cake with a cocktail stick at its highest point. If the cocktail stick comes out clean, the cake is ready.
The cake collapses.	Use less liquid next time or set the oven temperature 10 degrees lower and extend the baking time. Observe the specified mixing times in the recipe.
The cake has risen in the middle but is lower around the edge.	Only grease the base of the springform cake tin. After baking, loosen the cake carefully with a knife.
The cake is too dark.	Select a lower temperature and bake the cake for a little longer.
The cake is too dry.	When it is done, make small holes in the cake using a toothpick. Then drizzle fruit juice or an alcoholic beverage over it. Next time, select a temperature 10 degrees higher and reduce the baking time.
The bread or cake (e.g. cheesecake) looks good, but is soggy on the inside (sticky, streaked with water).	Use slightly less fluid next time and bake for slightly longer at a lower temperature. When baking cakes with a moist topping, bake the base first, cover with almonds or bread crumbs and then add the topping. Please follow the recipe and follow the baking times.
The cake cannot be turned out of the dish when it is turned upside down.	After baking, allow the cake to cool for a further 5 to 10 minutes, then it will be easier to turn out of the tin. If it still sticks, carefully loosen the cake around the edges using a knife. Turn the cake tin upside down again and cover it several times with a cold, wet cloth. Next time, grease the tin well and sprinkle some bread crumbs into it.
You have measured the temperature of the oven using your own meat thermometer and found there is a discrepancy.	The oven temperature is measured by the manufacturer after a specified period of time using a test rack in the centre of the cooking compartment. Ovenware and accessories affect the temperature measurement, so there will always be some discrepancy when you measure the temperature yourself.
Sparks are generated between the tin and the wire rack.	Check that the tin is clean on the outside. Change the position of the tin in the cooking compartment. If this does not help, continue baking but without the microwave. The baking time will then be longer.

Roasting and grilling

About the tables

The temperature and roasting time depend on the type and amount of food being cooked. This is why temperature ranges are given in the tables. Begin with the lower temperature and, if necessary, use a higher setting the next time,

For more information, see the section entitled *Tips for grilling and roasting* which follows the tables.

Ovenware

You may use any heat-resistant ovenware which is suitable for use in a microwave. Metal roasting dishes are not suitable for roasting with microwaves.

The ovenware can become very hot. Use oven gloves to take the ovenware out of the oven.

Place hot glass ovenware on a dry kitchen towel after they have been removed from the oven. The glass could crack if placed on a cold or wet surface.

Tips for roasting

Use a deep roasting dish for roasting meat and poultry.

Check that your ovenware fits in the cooking compartment. It should not be too big.

Meat:

Cover approx. two thirds of the ovenware base with liquid. Add a little more liquid for pot roasts. Turn pieces of meat halfway through the cooking time. When the roast is ready, turn off the

oven and allow it to rest for an additional 10 minutes. This allows better distribution of the meat juices.

Poultry:

Turn the pieces of meat after $\frac{2}{3}$ of the cooking time has elapsed.

Tips for grilling

Notes

- Always keep the oven door closed when grilling and do not preheat.
- As far as possible, the pieces of food you are grilling should be of equal thickness. Steaks should be at least 2 to 3 cm thick. This will allow them to brown evenly and remain succulent and juicy. Do not add salt to steaks until they have been grilled.
- Use tongs to turn the pieces of food you are grilling. If you pierce the meat with a fork, the juices will run out and it will become dry.
- Dark meat, e.g. beef, browns more quickly than lighter-coloured meat such as veal or pork. When grilling light-coloured meat or fish, these often only brown slightly on the surface, although they are cooked and juicy on the inside.
- The grill element switches off and on again automatically. This is normal. The grill setting determines how frequently this will happen.

Tips for braising

Use ovenware with a lid for braising fish.

Add two to three tablespoons of liquid and a little lemon juice or vinegar into the ovenware.

Meat, poultry, fish

	Microwave power setting in watts, cooking time in minutes	Level	Type of heating	Temperature in °C, grill setting	Notes
Pot-roasted beef approx. 1000 g	180 W, 80-90 mins	0		160-170	Ovenware with lid, on the cooking compartment floor.
Sirloin, medium rare approx. 1000 g	180 W, 30-40 mins	0		180-200	Uncovered dish. Turn half way through the cooking time. When finished, leave to stand for 10 minutes.
Pork without rind approx. 750 g, e.g. neck	360 W, 35-45 mins	0		170-180	Uncovered dish. When finished, leave to stand for 10 minutes.
Pork with rind* approx. 1 kg, e. g. shoulder	180 W, 80-90 mins	0		170-180	Uncovered dish. When finished, leave to stand for 10 minutes. Do not turn.
Pork loin approx. 500 to 600 g	180 W, 35-40 mins	0		180-190	Uncovered dish. When finished, leave to stand for 10 minutes.
Meat loaf approx. 750 g	360 W, 30-35 mins	0		200-210	Ovenware without lid, on the cooking compartment floor. When finished, leave to stand for 10 minutes.
Chicken, whole approx. 1000 to 1200 g	360 W, 30-40 mins	0		230-250	Ovenware with lid, on the cooking compartment floor. Place with the breast side up. Do not turn.
Chicken portions, e.g. chicken quarters approx. 800 g	360 W, 20-30 mins	0		230-250	Uncovered dish. Place with the skin side up. Do not turn.
Duck 1500 to 1700 g	180 W, 70-80 mins	0		220-240	Ovenware with lid, on the cooking compartment floor. Do not turn.
Duck breast approx. 500 g duck breast 2 pieces, 250 to 300 g each	180 W, 15-20 mins	0		3	Ovenware without lid, on the cooking compartment floor. Place with the skin side up. Do not turn.
Goose breast, goose legs 700 to 900 g	180 W, 30-40 mins	0		2	Deep cookware without lid, on the cooking compartment floor. Do not turn.
Fish, scalloped approx. 500 g	600 W, 10-15 mins	0		3	Uncovered dish. Defrost frozen fish before cooking.

* Make cuts in the rind for pork.

	Quantity	Weight	Level	Type of heating	Grill setting	Cooking time in minutes
Steaks 2 to 3 cm thick	2 to 3 pieces	approx. 200 g each	1+3**		3 3	1st side: approx. 10-15 2nd side: approx. 5-10
Neck steaks 2 to 3 cm thick	2 to 3 pieces	approx. 120 g each	1+3**		2 2	1st side: approx. 15-20 2nd side: approx. 10-15
Grilled sausages	4 to 6 pieces	approx. 150 g each	1+3**		3 3	1st side: approx. 10-15 2nd side: approx. 5-10
Fish steak*	2 to 3 pieces	approx. 150 g each	1+3**		3 3	1st side: approx. 10-12 2nd side: approx. 8-12
Fish, whole e. g. trout	2 to 3 pieces	approx. 300 g each	1+3**		2 2	1st side: approx. 10-15 2nd side: approx. 10-15
Toast	12 slices	-	3		3 3	1st side: approx. 3-5 2nd side: approx. 2-3
Toast	4 slices***	-	3		-	1st side: approx. 5-6 2nd side: approx. 3-4
Toast with topping	2 to 4 slices****	-	1+3**		3	Depending on topping: 8-10

* Grease the wire rack first with oil.

** Slide the wire rack in at level 3 and the baking tray at level 1.

*** Place the slices of bread next to each other in the centre of the wire rack.

**** Toast the slices of bread in advance

Tips for roasting and grilling



The table does not contain information for the weight of the joint.	For small roasts, select a higher temperature and a shorter cooking time. For larger roasts, select a lower temperature and a longer cooking time.
How to tell when the roast is ready.	Use a meat thermometer (available from specialist shops) or carry out a "spoon test". Press down on the roast with a spoon. If it feels firm, it is ready. If the spoon can be pressed in, it needs to be cooked for a little longer.
The roast looks good but the juices are burnt.	Next time, use a smaller roasting dish or add more liquid.
The roast looks good but the juices are too clear and watery.	Next time, use a larger roasting dish and add less liquid.
The roast is not well-done enough.	Carve the roast. Prepare the gravy in the roasting dish and place the slices of roast meat in the gravy. Finish cooking the meat using the microwave only.

Bakes, gratins

Notes

- The table applies to dishes placed in a cold oven.
- Place the bake in microwaveable ovenware on the cooking compartment floor.

- Use large flat ovenware for bakes and gratins. Food takes longer to cook in narrow, deep containers and browns more on top.
- Bakes and gratins should be left to cook in the oven for a further 5 minutes after the oven has been switched off.







Bakes, gratins	Ovenware	Level	Type of heating	Temperature in °C	Microwave power in watts	Cooking time in minutes
Sweet bakes (e.g. quark bake with fruit) approx. 1.5 kg	Shallow ovenproof dish 4 to 5 cm	0		130-150	180 W	25-35
Savoury bakes made from cooked ingredients (e.g. pasta bake) approx. 1 kg	Shallow ovenproof dish 4 to 5 cm	0		160-190	600 W	20-30
Savoury bakes made from raw ingredients (e.g. potato gratin) approx. 1.1 kg	Shallow ovenproof dish	0		170-180	600 W	25-35

Frozen convenience products

Notes

- Please observe the instructions on the packaging.

- The values in the table apply to dishes placed in a cold oven.
- Do not put chips, croquettes and rösti on top of each other!

Convenience products	Accessories	Level	Type of heating	Temperature in °C	Cooking time in minutes
Strudel with fruit filling	Baking tray	2		180-200	40-50
Chips	Baking tray	2		180-200	25-35
Pizza	Wire rack	2		180-200	10-20
Pizza baguette	Wire rack	2		160-190	15-20
Croquettes	Baking tray	2		180-200	25-35
Rösti	Baking tray	2		180-200	25-35

Test dishes

The quality and function of microwave combination appliances are tested by testing institutes using these dishes.

In accordance with EN 60705, IEC 60705 or DIN 44547 and EN 60350 (2009)

Microwave defrosting



Dish	Microwave power in watts Cooking time in minutes	Note
Meat	180 W, 7 + 90 W, 8-12 or programme 2, 500 g	Place Pyrex dish with a diameter of 22 cm on the oven floor.

Microwave cooking

Dish	Microwave power in watts Cooking time in minutes	Notes
Custard, 1000 g	600 W, 11-12 + 180 W, 15-20	Place Pyrex dish on the oven floor.

Dish	Microwave power in watts Cooking time in minutes	Notes
Sponge, 475 g	600 W, 8-10	Place Pyrex dish with a diameter of 22 cm on the oven floor.
Meat loaf, 900 g	600 W, 25-30	Place Pyrex dish on the oven floor.





Combined microwave cooking

Dish	Microwave power in watts Cooking time in minutes	Type of heating	Temperature in °C, grill setting	Notes
Potato gratin	360 W, 25-30		1	Place Pyrex dish with a diameter of 22 cm on the oven floor.
Cake	180 W, 20-25		190-200	Place Pyrex dish with a diameter of 22 cm on the wire rack, at level 1.
Chicken	360 W, 30-35		240	Put the chicken breast-side down in a deep dish without a lid and place on the cooking compartment floor. Turn half way through the cooking time.

Baking

In accordance with DIN 44547 and EN 60350

The values in the table apply to food placed in a cold oven.

	Accessories	Level	Type of heating	Temperature in °C	Baking time in minutes
Viennese whirls	Baking tray	2		160-170	30-35
Small Cakes*	Baking tray	2		160-170	25-30
Hot water sponge cake	Springform cake tin on the wire rack	1		170-180	45-50
Yeast cakes on a baking tray	Baking tray	2		150-160	50-60
Apple pie	20 cm diameter tinplate springform cake tin directly on the wire rack	2		170-190	80-100

* Preheat the oven for 5 minutes.

Grilling

The values in the table apply to dishes placed in a cold oven.

Dish	Accessories	Level	Grill, large area 	Cooking time in minutes
Toast	Wire rack	3	3	4-5
Beefburgers, x 12*	Wire rack + Baking tray	3 1	3	30-35

* Turn after half of the cooking time.

Acrylamide in foodstuffs

Which foods are affected?

Acrylamide is mainly produced in grain and potato products that are heated to high temperatures, such as potato crisps,

chips, toast, bread rolls, bread, fine baked goods (biscuits, gingerbread, cookies).

Tips for keeping acrylamide to a minimum when preparing food

General	Keep cooking times to a minimum. Cook meals until they are golden brown, but not too dark. Large, thick pieces of food contain less acrylamide.
Baking biscuits	Max. 200 °C in Top/bottom heating or max. 180 °C in 3D hot air or hot air mode. Max. 190° C in Top/bottom heating or max. 170 °C in 3D hot air or hot air mode. Egg white and egg yolk reduce the formation of acrylamide.
Oven chips	Distribute thinly and evenly over the baking tray. Cook at least 400 g at once on a baking tray so that the chips do not dry out.









Robert Bosch Hausgeräte GmbH

Carl-Wery-Straße 34

81739 München

Germany

www.bosch-home.com



9000773700

(02)
930916